

*ASSP Mobile Communication Systems***Piezoelectric SAW BPF
(1000 to 2500 MHz)****F6 Series (L2 type)****DESCRIPTION**

The F6 series of SAW band pass filters apply to the frequency range 1000 to 2500 MHz.

The SAW filters are fabricated on a lithium tantalate (LiTaO_3) substrate, producing filters with a wide frequency bandwidth, low insertion loss in passband and superior stability due to the high electromechanical coupling coefficient of the material.

Fujitsu's leading techniques for making filter pattern designs realized this high frequency filter.

The F6 series filters are housed in a small surface mount package. Moreover, the impedance in the passband is 50Ω , and so applications require no external matching circuits.

The F6 series SAW filters are suitable for interstage RF filter in mobile communications systems in the sub microwave frequency band. Standard devices are available for PCS, DCS1800, and 2.4 GHz wireless LAN systems.

FEATURES

- High frequency filters
- Low insertion loss
- Ultra compact and light package (3.0 mm sq.)
- External matching circuits are not required.
- Surface mount package (SMT)
- Wide variety of standard devices for worldwide mobile communication systems

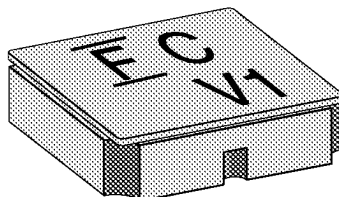
PACKAGE

F6 Series (L2 type)

■ PIN ASSIGNMENT

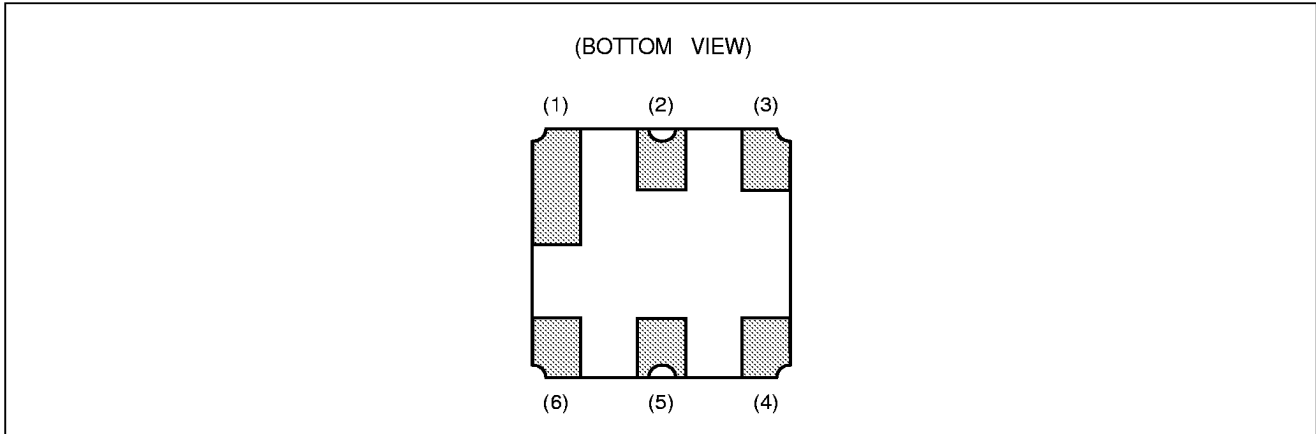

■ PIN DESCRIPTION

Pin No.	Pin name	Description
1	GND	Ground
2	IN	Input
3	GND	Ground
4	GND	Ground
5	OUT	Output
6	GND	Ground

■ ABSOLUTE MAXIMUM RATINGS

Parameter	Symbol	Value		Unit
		Min.	Max.	
Operating temperature	T _a	-30	+85	°C
Storage temperature	T _{stg}	-40	+100	°C
Maximum input level	P _{IN}	Refer to electrical characteristics		mW

WARNING: Semiconductor devices can be permanently damaged by application of stress (voltage, current, temperature, etc.) in excess of absolute maximum ratings. Do not exceed these ratings.

F6 Series (L2 type)

■ RECOMMENDED OPERATING CONDITIONS (See WARNING)

Parameter	Symbol	Value		Unit
		Min.	Max.	
Operating temperature	Ta	-30 *	+85 *	°C

* : Standard Rating for Wireless LAN Systems is 0 to +60°C.

WARNING: Recommended operating conditions are normal operating ranges for the semiconductor device. All the device's electrical characteristics are warranted when operated within these ranges.

Always use semiconductor devices within the recommended operating conditions. Operation outside these ranges may adversely affect reliability and could result in device failure.

No warranty is made with respect to uses, operating conditions, or combinations not represented on the data sheet. Users considering application outside the listed conditions are advised to contact their FUJITSU representative beforehand.

■ STANDARD FREQUENCIES

System	Center freq. (MHz)	Band width	Part symbol	Part number	Remarks	
GPS	1575.42	2	6	FAR-F6CE-1G5754-L2UA		
PCN	Tx	1747.5	75	A	FAR-F6CE-1G7475-L2YA	
	Rx	1842.5	75	B	FAR-F6CE-1G8425-L2YB	
US-PCS	Tx	1880.0	60	C	FAR-F6CE-1G8800-L2XA	
		1880.0	60	c	FAR-F6CE-1G8800-L2XZ	High Att. type
		1880.0	60	g	FAR-F6CE-1G8800-L2XJ	High Att. at Rx band
	Rx	1960.0	60	D	FAR-F6CE-1G9600-L2XB	
		1960.0	60	f	FAR-F6CE-1G9600-L2XY	High Att. type
K-PCS	Tx	1750.0	60	A	FAR-F6CE-1G7475-L2YAC	
		1730.0	40	K	FAR-F6CE-1G7300-L2TC	
		1765.0	30	S	FAR-F6CE-1G7650-L2TA	
	Rx	1840.0	60	B	FAR-F6CE-1G8425-L2YBC	
		1820.0	40	W	FAR-F6CE-1G8200-L2TD	
		1855.0	30	T	FAR-F6CE-1G8550-L2TB	
Wireless LAN		2448.5	97	E	FAR-F6CE-2G4500-L2WA	
		2484.0	26	P	FAR-F6CE-2G4840-L2WC	For Japan
		2441.8	83	L	FAR-F6CE-2G4418-L2WD	For Europe, USA

F6 Series (L2 type)

■ ELECTRICAL CHARACTERISTICS (STANDARD VERSION)

1. GPS

Part number: FAR-F6CE-1G5754-L2UA

(Ta = -30 to +85°C)

Parameter	Symbol	Conditions	Value			Unit	Remarks
			Min.	Typ.	Max.		
Insertion loss	IL	1574.42 to 1776.42 MHz	—	2.7	3.5	dB	
In-band deviation	—	1574.42 to 1776.42 MHz	—	0.2	1.0	dB	
Absolute stopband attenuation	—	1475.42 MHz	35	37	—	dB	
	—	1525.42 MHz	35	50	—	dB	
	—	1625.42 MHz	30	38	—	dB	
	—	1675.42 MHz	30	35	—	dB	
In-band VSWR	—	1574.42 to 1776.42 MHz	—	1.4	2.0	—	
Max. input power	P _{IN}	1574.42 to 1776.42 MHz	—	—	10	mW	

2. PCN (Tx)

Part number: FAR-F6CE-1G7475-L2YA

(Ta = -30 to +85°C)

Parameter	Symbol	Conditions	Value			Unit	Remarks
			Min.	Typ.	Max.		
Insertion loss	IL	1710 to 1785 MHz	—	3.0	4.2	dB	
In-band deviation	—	1710 to 1785 MHz	—	1.8	2.7	dB	
Absolute stopband attenuation	—	D.C. to 1500 MHz	17	19	—	dB	
	—	1500 to 1670 MHz	20	22	—	dB	
	—	1805 to 1880 MHz	7	12	—	dB	
	—	1880 to 2200 MHz	20	23	—	dB	
	—	3420 to 3570 MHz	25	31	—	dB	
	—	5130 to 5355 MHz	15	25	—	dB	
In-band VSWR	—	1710 to 1785 MHz	—	2.5	3.0	—	
Max. input power	P _{IN}	1710 to 1785 MHz	—	—	20	mW	

F6 Series (L2 type)

3. PCN (Rx)

Part number: FAR-F6CE-1G8425-L2YB

(Ta = -30 to +85°C)

Parameter	Symbol	Conditions	Value			Unit	Remarks
			Min.	Typ.	Max.		
Insertion loss	IL	1805 to 1880 MHz	—	3.3	4.5	dB	
In-band deviation	—	1805 to 1880 MHz	—	1.5	2.5	dB	
Absolute stopband attenuation	—	D.C. to 1500 MHz	20	22	—	dB	
	—	1600 to 1710 MHz	22	24	—	dB	
	—	1710 to 1785 MHz	10	29	—	dB	
	—	1920 to 2400 MHz	25	27	—	dB	
	—	3610 to 3760 MHz	25	35	—	dB	
—	5415 to 5640 MHz	15	21	—	dB		
In-band VSWR	—	1805 to 1880 MHz	—	2.5	3.0	—	
Max. input power	P _{IN}	1805 to 1880 MHz	—	—	20	mW	

4. US-PCS (Tx)

Part number: FAR-F6CE-1G8800-L2XA

(Ta = -30 to +85°C)

Parameter	Symbol	Conditions	Value			Unit	Remarks
			Min.	Typ.	Max.		
Insertion loss	IL	1850 to 1910 MHz	—	3.2	4.2	dB	
In-band deviation	—	1850 to 1910 MHz	—	2.0	2.5	dB	
Absolute stopband attenuation	—	D.C. to 1500 MHz	20	22	—	dB	
	—	1500 to 1800 MHz	23	25	—	dB	
	—	1930 to 1990 MHz	7	18	—	dB	
	—	3700 to 3820 MHz	25	32	—	dB	
	—	5550 to 5730 MHz	15	21	—	dB	
In-band VSWR	—	1850 to 1910 MHz	—	2.0	2.5	—	
Max. input power	P _{IN}	1850 to 1910 MHz	—	—	20	mW	

F6 Series (L2 type)

5. US-PCS (Tx) High Attenuation type

Part number: FAR-F6CE-1G8800-L2XZ

(Ta = -30 to +85°C)

Parameter	Symbol	Conditions	Value			Unit	Remarks
			Min.	Typ.	Max.		
Insertion loss	IL	1850 to 1910 MHz	—	3.7	5.0	dB	
In-band deviation	—	1850 to 1910 MHz	—	1.7	3.0	dB	
Absolute stopband attenuation	—	D.C. to 120 MHz	40	47	—	dB	
	—	120 to 200 MHz	38	42	—	dB	
	—	200 to 1500 MHz	32	34	—	dB	
	—	1500 to 1800 MHz	35	38	—	dB	
	—	1930 to 1990 MHz	7	17	—	dB	
	—	1990 to 2200 MHz	35	41	—	dB	
	—	2200 to 2350 MHz	40	43	—	dB	
	—	2350 to 4000 MHz	20	32	—	dB	
—	4000 to 5000 MHz	5	9	—	dB		
In-band VSWR	—	1850 to 1910 MHz	—	2.3	2.8	—	
Max. input power	P _{IN}	1850 to 1910 MHz	—	—	20	mW	

6. US-PCS (Tx) High Attenuation at Rx band type

Part number: FAR-F6CE-1G8800-L2XJ

(Ta = -30 to +85°C)

Parameter	Symbol	Conditions	Value			Unit	Remarks
			Min.	Typ.	Max.		
Insertion loss	IL	1850 to 1910 MHz	—	2.7	4.2	dB	
In-band deviation	—	1850 to 1910 MHz	—	1.2	2.6	dB	
Absolute stopband attenuation	—	D.C. to 1500 MHz	15	20	—	dB	
	—	1500 to 1750 MHz	20	22	—	dB	
	—	1930 to 1990 MHz	9	15	—	dB	
	—	1990 to 2300 MHz	20	25	—	dB	
	—	2300 to 2500 MHz	15	20	—	dB	
In-band VSWR	—	1850 to 1910 MHz	—	2.2	2.5	—	
Max. input power	P _{IN}	1850 to 1910 MHz	—	—	20	mW	

F6 Series (L2 type)

7. US-PCS (Rx)

Part number: FAR-F6CE-1G9600-L2XB

(Ta = -30 to +85°C)

Parameter	Symbol	Conditions	Value			Unit	Remarks
			Min.	Typ.	Max.		
Insertion loss	IL	1930 to 1990 MHz	—	3.3	4.5	dB	
In-band deviation	—	1930 to 1990 MHz	—	2.0	2.8	dB	
Absolute stopband attenuation	—	D.C. to 1500 MHz	21	23	—	dB	
	—	1500 to 1850 MHz	23	25	—	dB	
	—	1850 to 1910 MHz	10	30	—	dB	
	—	3860 to 3980 MHz	25	32	—	dB	
	—	5790 to 5970 MHz	15	23	—	dB	
In-band VSWR	—	1930 to 1990 MHz	—	1.8	2.5	—	
Max. input power	P _{IN}	1930 to 1990 MHz	—	—	20	mW	

8. US-PCS (Rx) High Attenuation type

Part number: FAR-F6CE-1G9600-L2XY

(Ta = -30 to +85°C)

Parameter	Symbol	Conditions	Value			Unit	Remarks
			Min.	Typ.	Max.		
Insertion loss	IL	1930 to 1990 MHz	—	3.5	5.0	dB	
In-band deviation	—	1930 to 1990 MHz	—	1.0	2.5	dB	
Absolute stopband attenuation	—	D.C. to 100 MHz	40	42	—	dB	
	—	100 to 200 MHz	35	36	—	dB	
	—	200 to 1100 MHz	25	30	—	dB	
	—	1100 to 1190 MHz	29	31	—	dB	
	—	1190 to 1700 MHz	30	32	—	dB	
	—	1700 to 1850 MHz	35	41	—	dB	
	—	1850 to 1880 MHz	25	47	—	dB	
	—	1880 to 1910 MHz	8	12	—	dB	
	—	2010 to 2040 MHz	8	15	—	dB	
	—	2040 to 2070 MHz	25	48	—	dB	
	—	2070 to 2300 MHz	40	41	—	dB	
	—	2300 to 3100 MHz	35	37	—	dB	
	—	3100 to 3700 MHz	33	36	—	dB	
	—	3700 to 4800 MHz	25	35	—	dB	
—	4800 to 6000 MHz	10	14	—	dB		
In-band VSWR	—	1930 to 1990 MHz	—	2.3	2.6	—	
Max. input power	P _{IN}	1930 to 1990 MHz	—	—	20	mW	

F6 Series (L2 type)

9. Korea-PCS (Tx) 60 MHz Band Width

Part number: FAR-F6CE-1G7475-L2YAC

(Ta = -30 to +85°C)

Parameter	Symbol	Conditions	Value			Unit	Remarks
			Min.	Typ.	Max.		
Insertion loss	IL	1720 to 1780 MHz	—	2.5	3.5	dB	
In-band deviation	—	1720 to 1780 MHz	—	1.0	2.0	dB	
Absolute stopband attenuation	—	D.C. to 1500 MHz	17	19	—	dB	
	—	1500 to 1670 MHz	20	22	—	dB	
	—	1810 to 1870 MHz	12	18	—	dB	
	—	1870 to 2200 MHz	20	23	—	dB	
	—	3420 to 3570 MHz	25	31	—	dB	
—	5130 to 5355 MHz	15	25	—	dB		
In-band VSWR	—	1720 to 1780 MHz	—	2.5	3.0	—	
Max. input power	P _{IN}	1720 to 1780 MHz	—	—	20	mW	

10. Korea-PCS (Tx) Lower 40 MHz Band Width

Part number: FAR-F6CE-1G7300-L2TC

(Ta = -30 to +85°C)

Parameter	Symbol	Conditions	Value			Unit	Remarks
			Min.	Typ.	Max.		
Insertion loss	IL	1710 to 1750 MHz	—	2.2	3.0	dB	
In-band deviation	—	1710 to 1750 MHz	—	1.2	1.5	dB	
Absolute stopband attenuation	—	1310 to 1350 MHz	20	27	—	dB	
	—	1620 to 1660 MHz	30	36	—	dB	
	—	1800 to 1840 MHz	30	34	—	dB	
	—	2110 to 2150 MHz	25	33	—	dB	
In-band VSWR	—	1710 to 1750 MHz	—	1.9	2.3	—	
Max. input power	P _{IN}	1710 to 1750 MHz	—	—	20	mW	

F6 Series (L2 type)

11. Korea-PCS (Tx) Upper 30 MHz Band Width Part number: FAR-F6CE-1G7650-L2TA

(Ta = -30 to +85°C)

Parameter	Symbol	Conditions	Value			Unit	Remarks
			Min.	Typ.	Max.		
Insertion loss	IL	1750 to 1780 MHz	—	2.2	2.5	dB	Ta = +25°C
					3.0		Ta = -30 to +85°C
In-band deviation	—	1750 to 1780 MHz	—	1.2	1.5	dB	
Absolute stopband attenuation	—	1350 to 1380 MHz	25	27	—	dB	
	—	1660 to 1690 MHz	30	40	—	dB	
	—	1840 to 1870 MHz	30	35	—	dB	
	—	2150 to 2180 MHz	30	33	—	dB	
In-band VSWR	—	1750 to 1780 MHz	—	1.8	2.0	—	
Max. input power	P _{IN}	1750 to 1780 MHz	—	—	20	mW	

12. Korea-PCS (Rx) 60 MHz Band Width Part number: FAR-F6CE-1G8425-L2YBC

(Ta = -30 to +85°C)

Parameter	Symbol	Conditions	Value			Unit	Remarks
			Min.	Typ.	Max.		
Insertion loss	IL	1810 to 1870 MHz	—	3.0	3.5	dB	
In-band deviation	—	1810 to 1870 MHz	—	1.5	2.0	dB	
Absolute stopband attenuation	—	D.C. to 1500 MHz	20	22	—	dB	
	—	1500 to 1720 MHz	22	24	—	dB	
	—	1720 to 1780 MHz	20	33	—	dB	
	—	1920 to 2400 MHz	25	27	—	dB	
	—	3610 to 3760 MHz	25	35	—	dB	
	—	5415 to 5640 MHz	15	21	—	dB	
In-band VSWR	—	1810 to 1870 MHz	—	2.5	3.0	—	
Max. input power	P _{IN}	1810 to 1870 MHz	—	—	20	mW	

F6 Series (L2 type)

13. Korea-PCS (Rx) Lower 40 MHz Band Width

Part number: FAR-F6CE-1G8200-L2TD

(Ta = -30 to +85°C)

Parameter	Symbol	Conditions	Value			Unit	Remarks
			Min.	Typ.	Max.		
Insertion loss	IL	1800 to 1840 MHz	—	2.2	3.0	dB	
In-band deviation	—	1800 to 1840 MHz	—	1.0	1.3	dB	
Absolute stopband attenuation	—	1400 to 1440 MHz	20	27	—	dB	
	—	1710 to 1750 MHz	30	40	—	dB	
	—	1890 to 1930 MHz	30	35	—	dB	
	—	2200 to 2240 MHz	25	33	—	dB	
In-band VSWR	—	1800 to 1840 MHz	—	2.1	2.3	—	
Max. input power	P _{IN}	1800 to 1840 MHz	—	—	20	mW	

14. Korea-PCS (Rx) Upper 30 MHz Band Width

Part number: FAR-F6CE-1G8550-L2TB

(Ta = -30 to +85°C)

Parameter	Symbol	Conditions	Value			Unit	Remarks
			Min.	Typ.	Max.		
Insertion loss	IL	1840 to 1870 MHz	—	2.2	2.5	dB	Ta = +25°C
					3.0	dB	Ta = -30 to +85°C
In-band deviation	—	1840 to 1870 MHz	—	1.1	1.5	dB	
Absolute stopband attenuation	—	1440 to 1470 MHz	25	28	—	dB	
	—	1750 to 1780 MHz	30	40	—	dB	
	—	1930 to 1960 MHz	30	40	—	dB	
	—	2240 to 2270 MHz	30	34	—	dB	
In-band VSWR	—	1840 to 1870 MHz	—	1.7	2.0	—	
Max. input power	P _{IN}	1840 to 1870 MHz	—	—	20	mW	

F6 Series (L2 type)

15. Wireless-LAN 97 MHz Band Width

Part number: FAR-F6CE-2G4500-L2WA

(Ta = 0 to +60°C)

Parameter	Symbol	Conditions	Value			Unit	Remarks
			Min.	Typ.	Max.		
Insertion loss	IL	2400 to 2497 MHz	—	4.0	5.0	dB	
In-band deviation	—	2400 to 2497 MHz	—	2.0	3.0	dB	
Absolute stopband attenuation	—	D.C. to 1700 MHz	20	22	—	dB	
	—	1800 to 2200 MHz	25	27	—	dB	
	—	2700 to 3100 MHz	30	33	—	dB	
	—	4800 to 5000 MHz	10	16	—	dB	
In-band VSWR	—	2400 to 2497 MHz	—	2.2	2.6	—	
Max. input power	P _{IN}	2400 to 2497 MHz	—	—	10	mW	

16. Wireless-LAN 26 MHz Band Width (For Japan)

Part number: FAR-F6CE-2G4840-L2WC

(Ta = 0 to +60°C)

Parameter	Symbol	Conditions	Value			Unit	Remarks
			Min.	Typ.	Max.		
Insertion loss	IL	2471 to 2497 MHz	—	2.5	3.5	dB	
In-band deviation	—	2471 to 2497 MHz	—	1.0	1.5	dB	
Absolute stopband attenuation	—	D.C. to 1700 MHz	20	23	—	dB	
	—	1800 to 2200 MHz	25	27	—	dB	
	—	2700 to 3100 MHz	30	33	—	dB	
	—	4800 to 5000 MHz	10	16	—	dB	
In-band VSWR	—	2471 to 2497 MHz	—	1.5	2.0	—	
Max. input power	P _{IN}	2471 to 2497 MHz	—	—	10	mW	

F6 Series (L2 type)

17. Wireless-LAN 83.5 MHz Band Width (For Europe, USA)

Part number: FAR-F6CE-2G4418-L2WD

(Ta = 0 to +60°C)

Parameter	Symbol	Conditions	Value			Unit	Remarks
			Min.	Typ.	Max.		
Insertion loss	IL	2400 to 2483.5 MHz	—	3.2	4.5	dB	
In-band deviation	—	2400 to 2483.5 MHz	—	1.3	2.5	dB	
Absolute stopband attenuation	—	D.C. to 1700 MHz	20	22	—	dB	
	—	1800 to 2200 MHz	25	27	—	dB	
	—	2700 to 3100 MHz	30	33	—	dB	
	—	4800 to 5000 MHz	10	16	—	dB	
In-band VSWR	—	2400 to 2483.5 MHz	—	2.2	2.6	—	
Max. input power	P _{IN}	2400 to 2483.5 MHz	—	—	10	mW	

F6 Series (L2 type)

■ TYPICAL CHARACTERISTICS (STANDARD VERSION)

1. GPS

Part number: FAR-F6CE-1G5754-L2UA

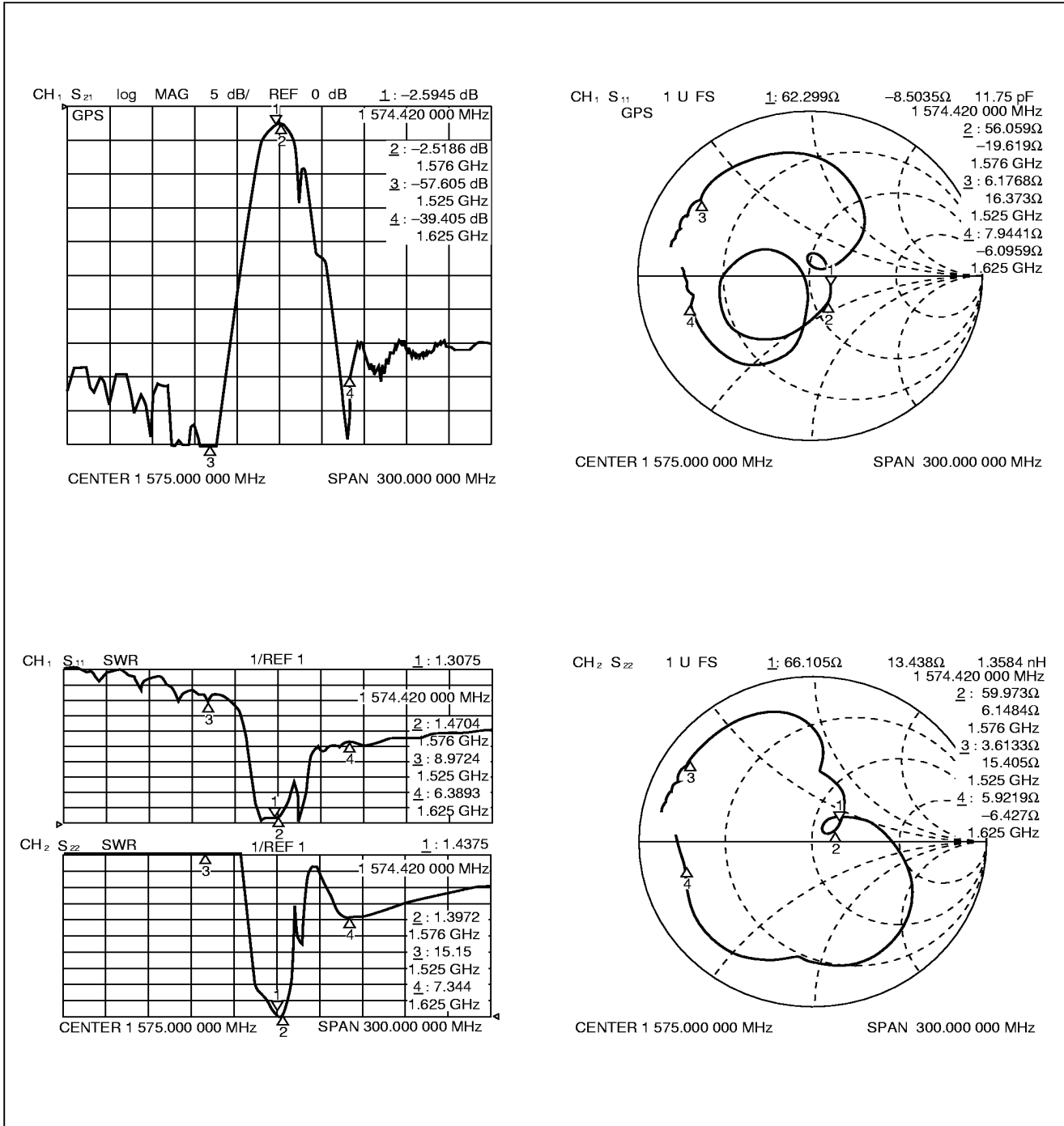

F6 Series (L2 type)

2. PCN (Tx)

Part number: FAR-F6CE-1G7475-L2YA

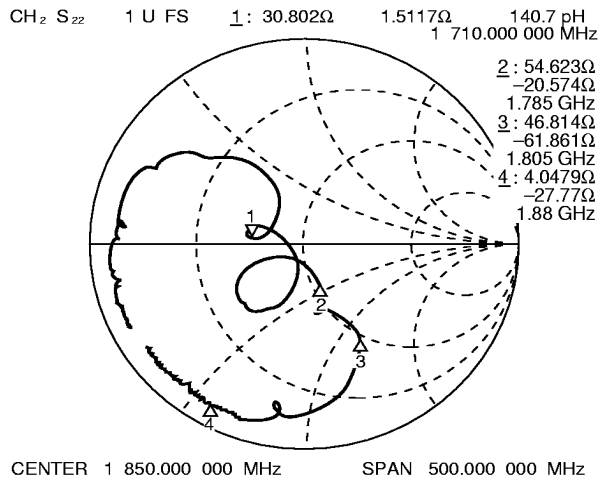
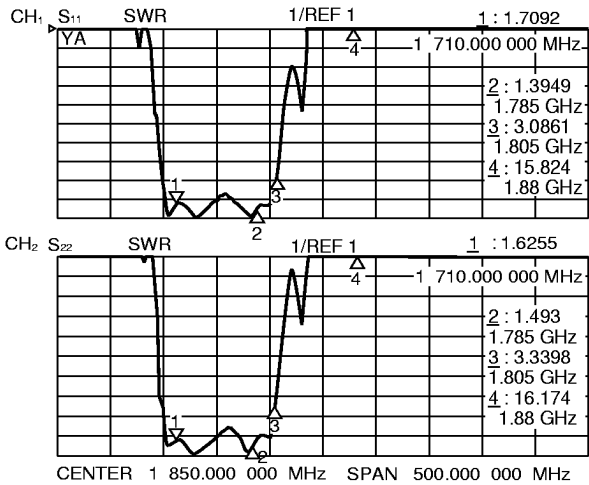
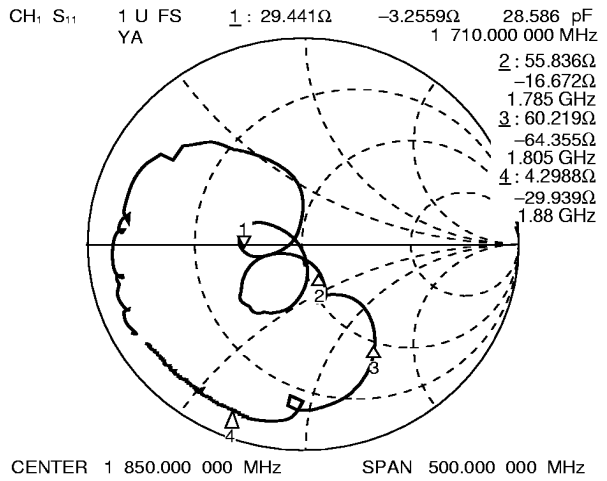
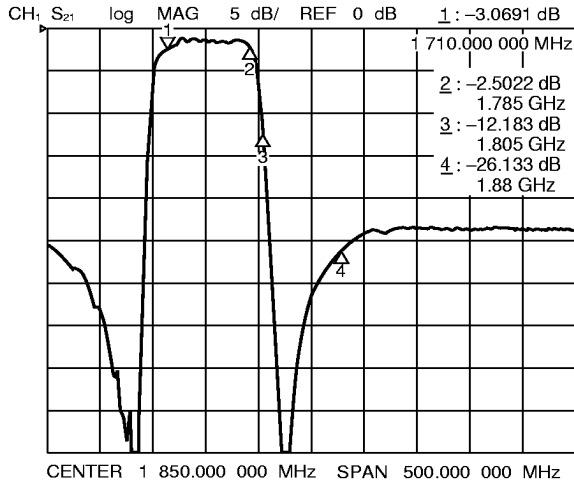

F6 Series (L2 type)

3. PCN (Rx)

Part number: FAR-F6CE-1G8425-L2YB

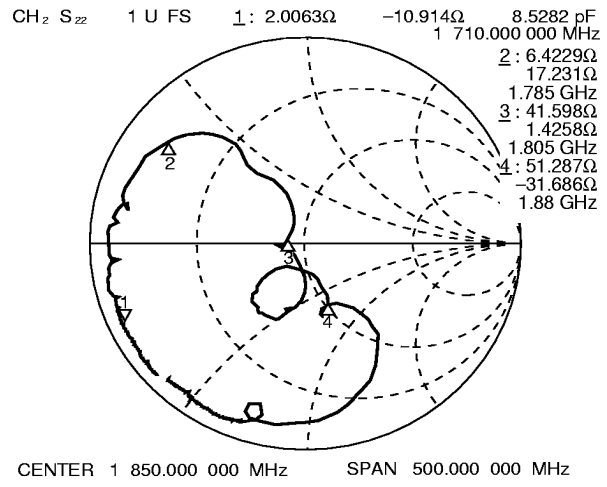
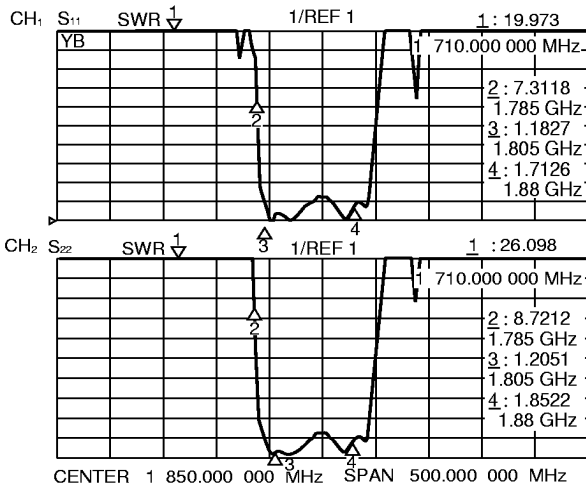
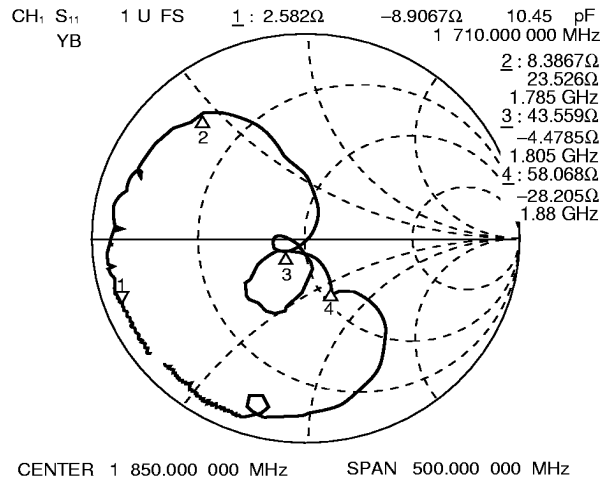
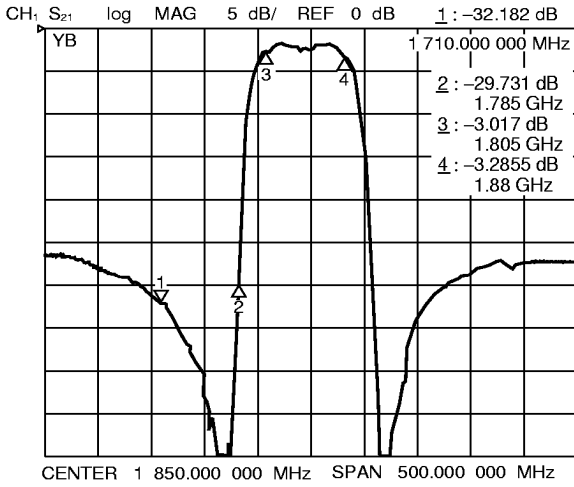

F6 Series (L2 type)

4. US-PCS (Tx)

Part number: FAR-F6CE-1G8800-L2XA

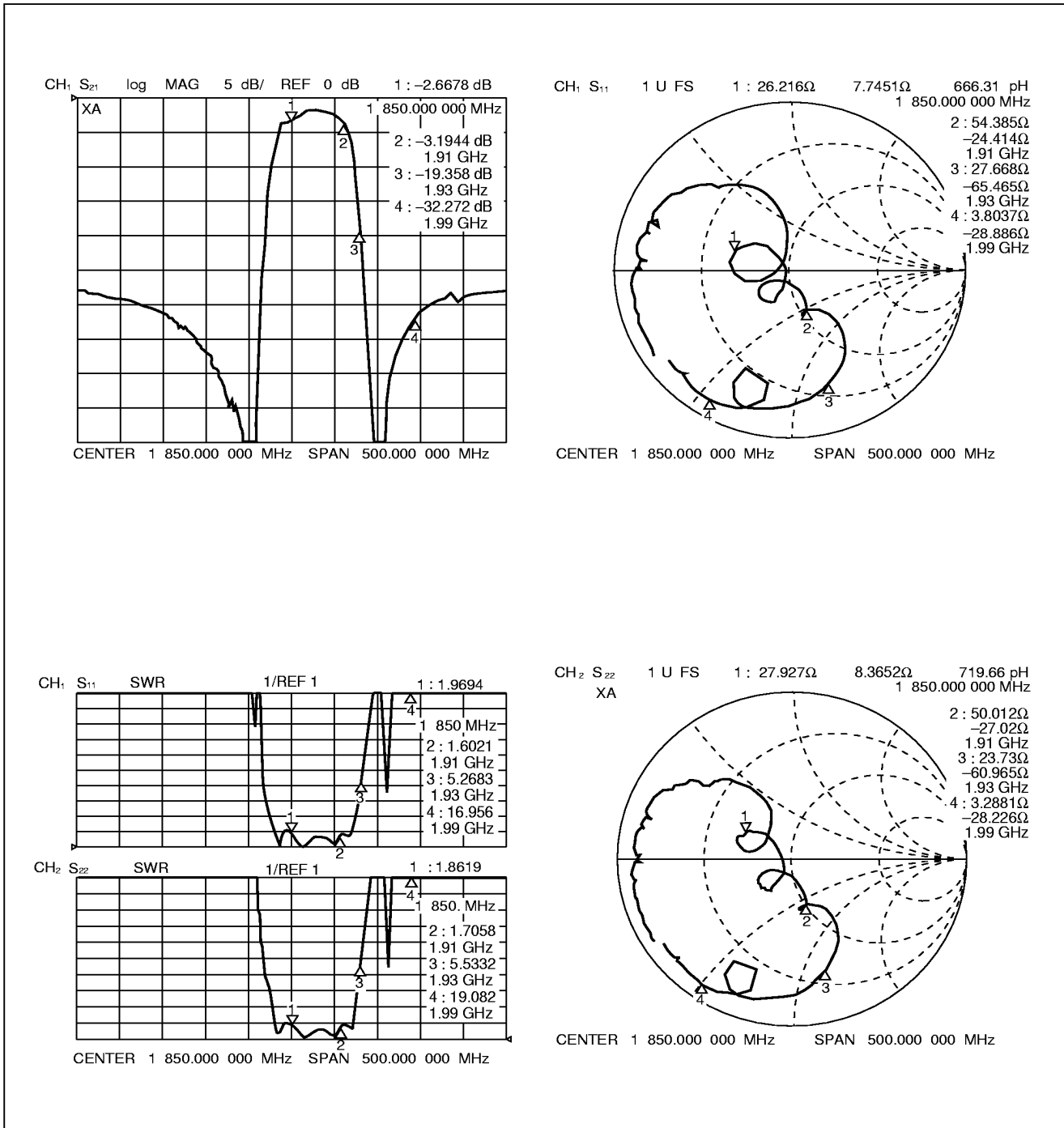

F6 Series (L2 type)

5. US-PCS (Tx) High Attenuation type Part number: FAR-F6CE-1G8800-L2XZ

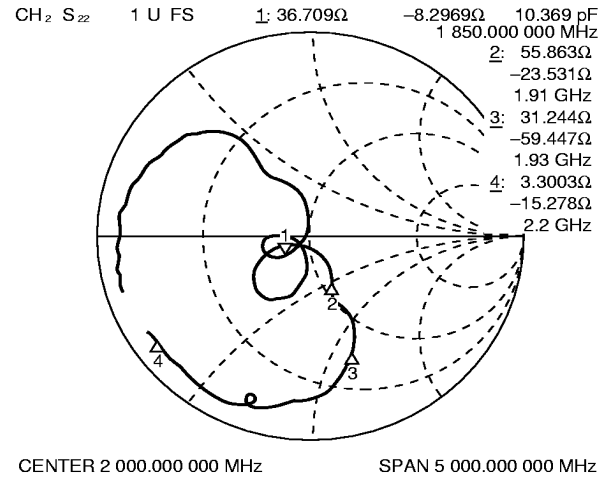
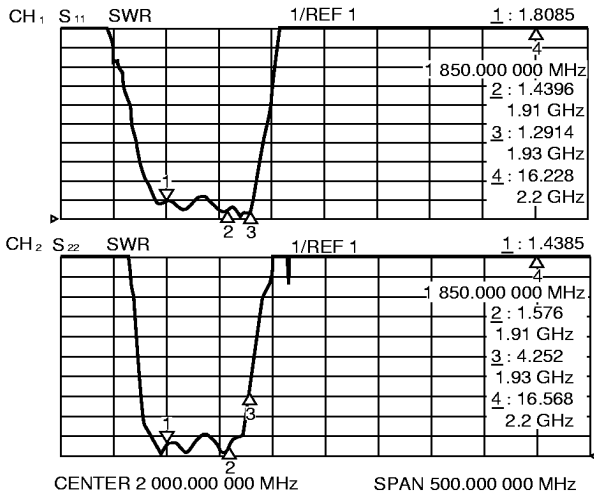
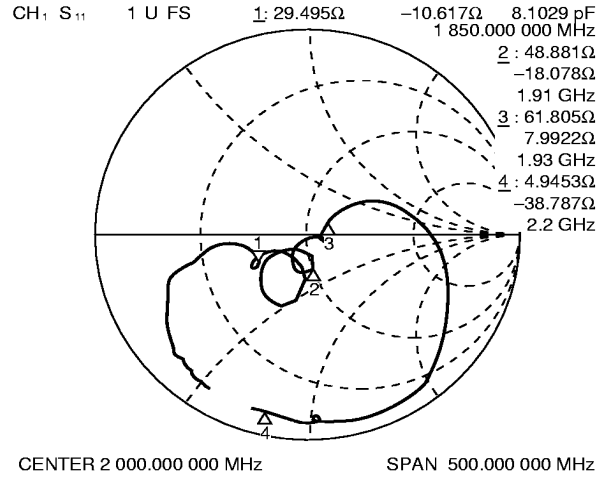
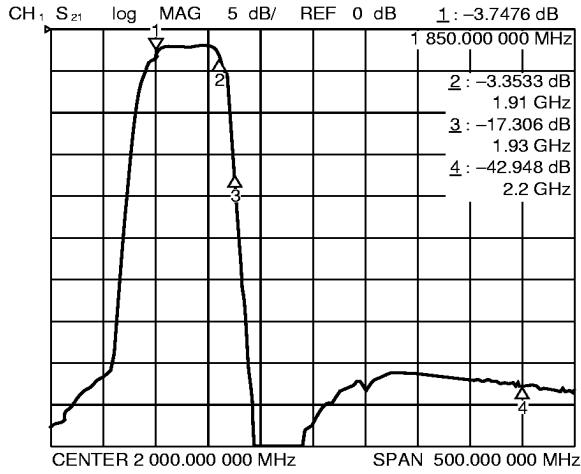

F6 Series (L2 type)

6. US-PCS (Tx) High Attenuation at Rx band type Part number: FAR-F6CE-1G8800-L2XJ

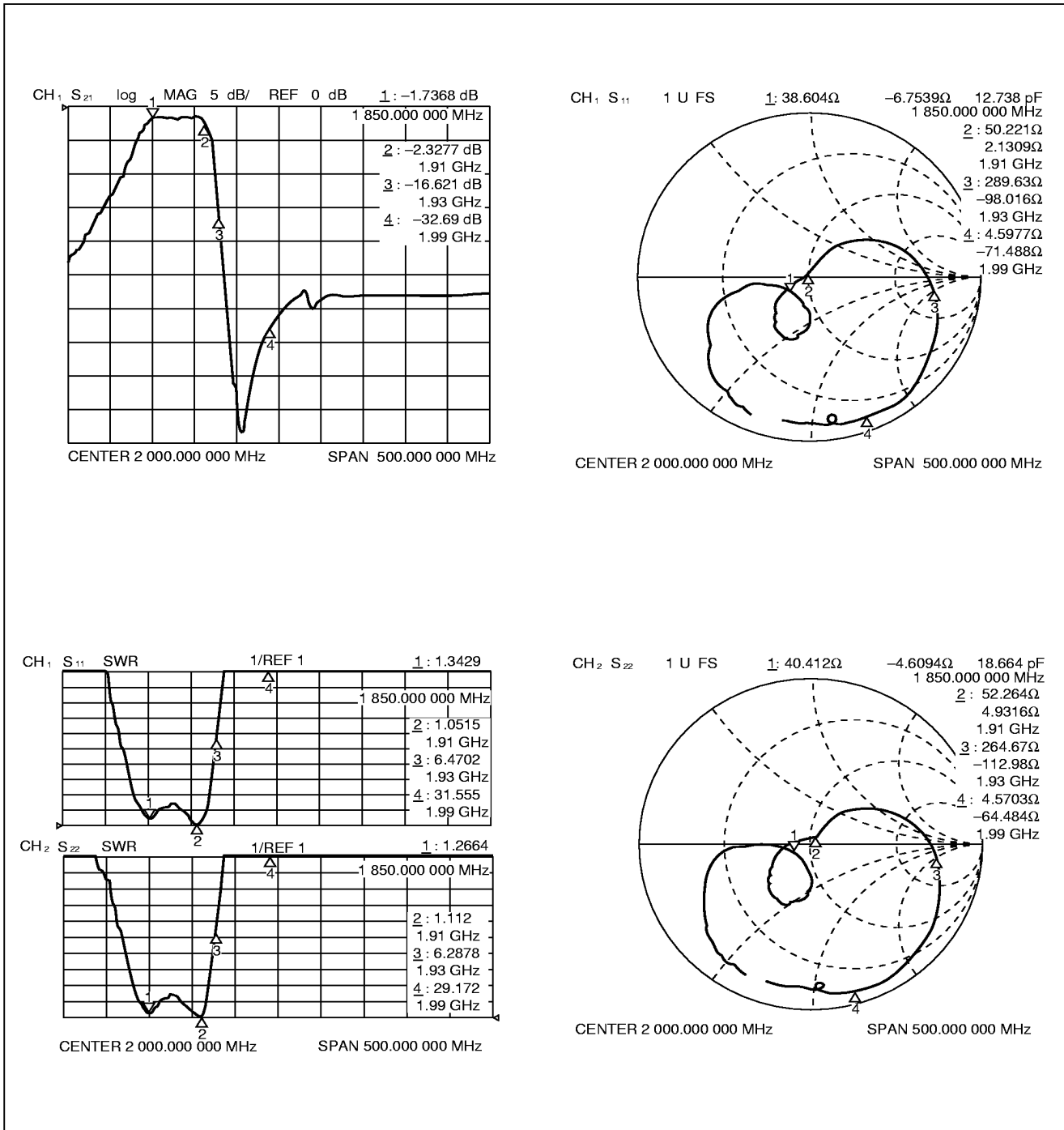

F6 Series (L2 type)

7. US-PCS (Rx)

Part number: FAR-F6CE-1G9600-L2XB

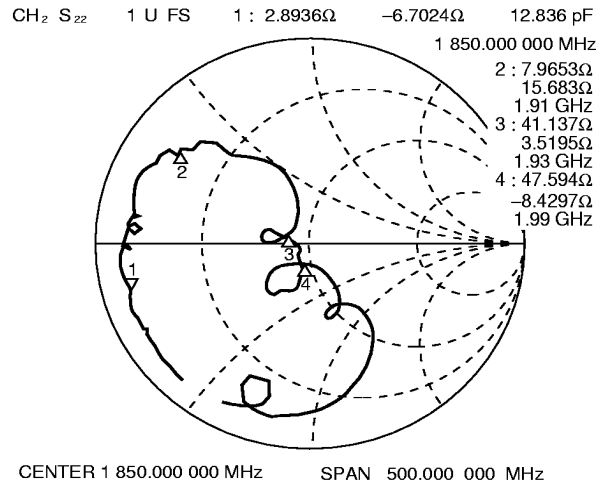
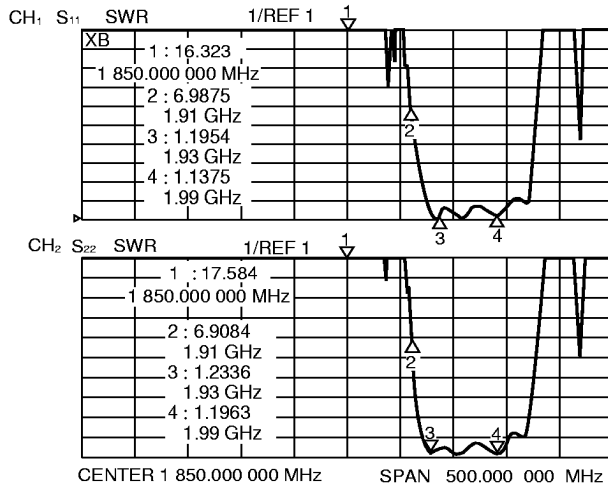
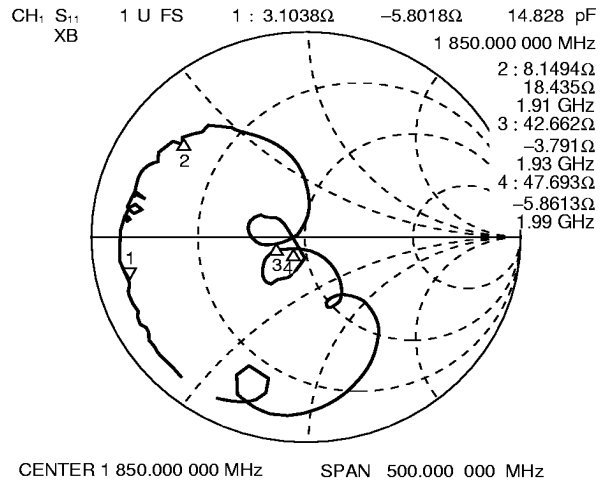
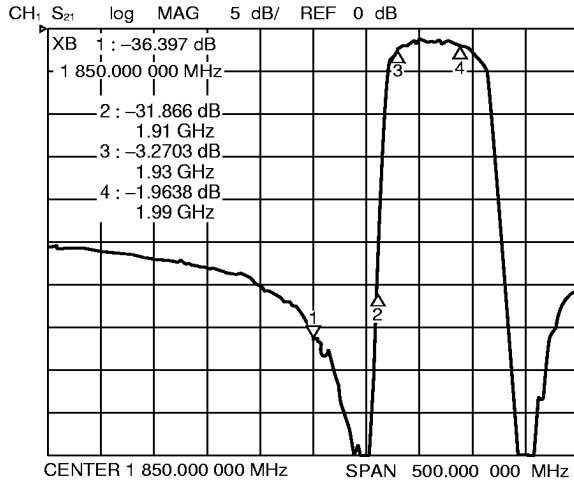

F6 Series (L2 type)

8. US-PCS (Rx) High Attenuation type Part number: FAR-F6CE-1G9600-L2XY

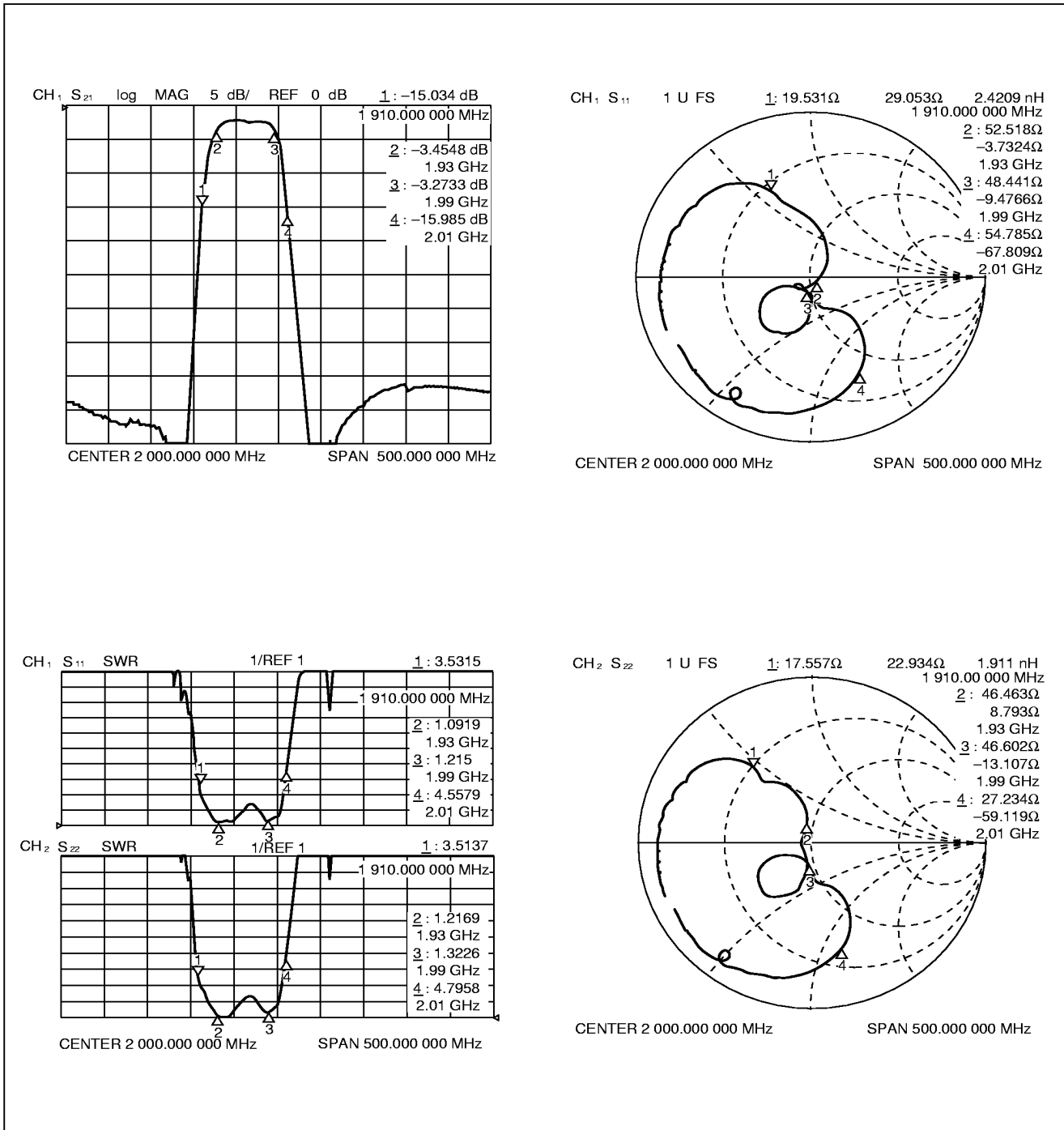

F6 Series (L2 type)

9. Korea-PCS (Tx) 60 MHz Band Width Part number: FAR-F6CE-1G7475-L2YAC

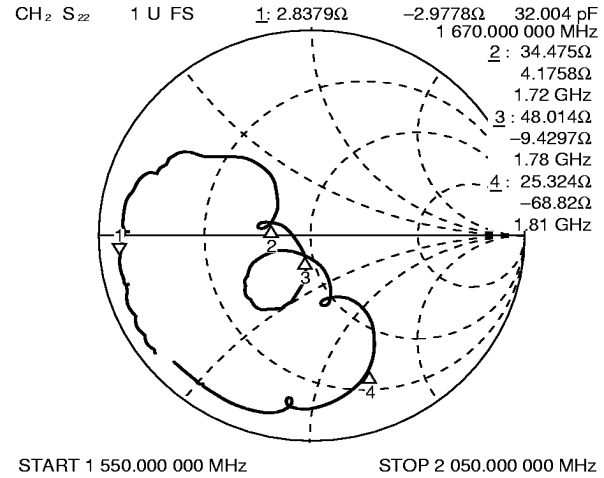
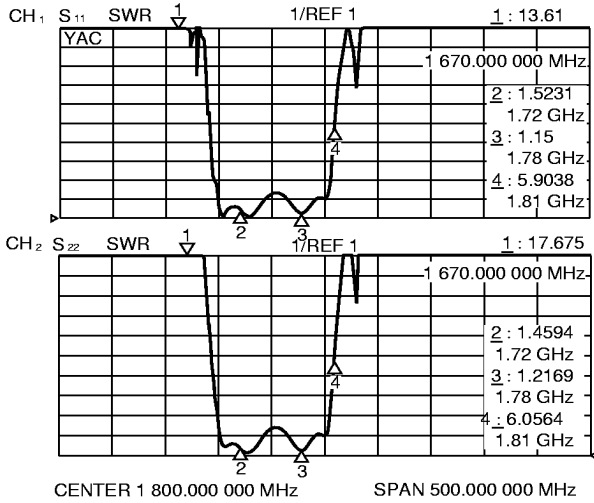
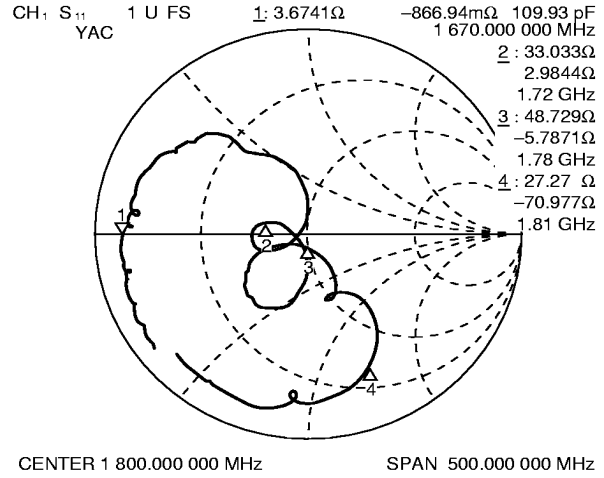
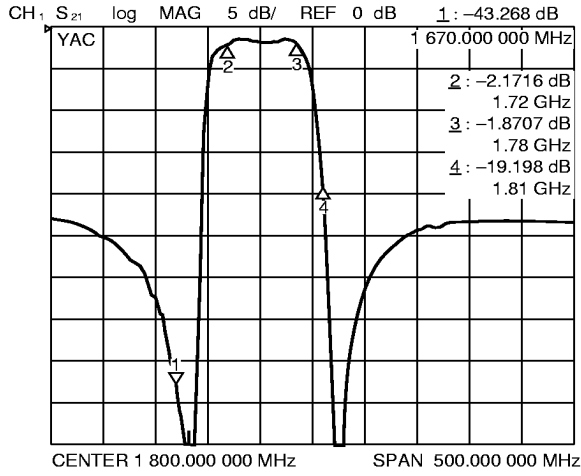

F6 Series (L2 type)

10. Korea-PCS (Tx) Lower 40 MHz Band Width Part number: FAR-F6CE-1G7300-L2TC

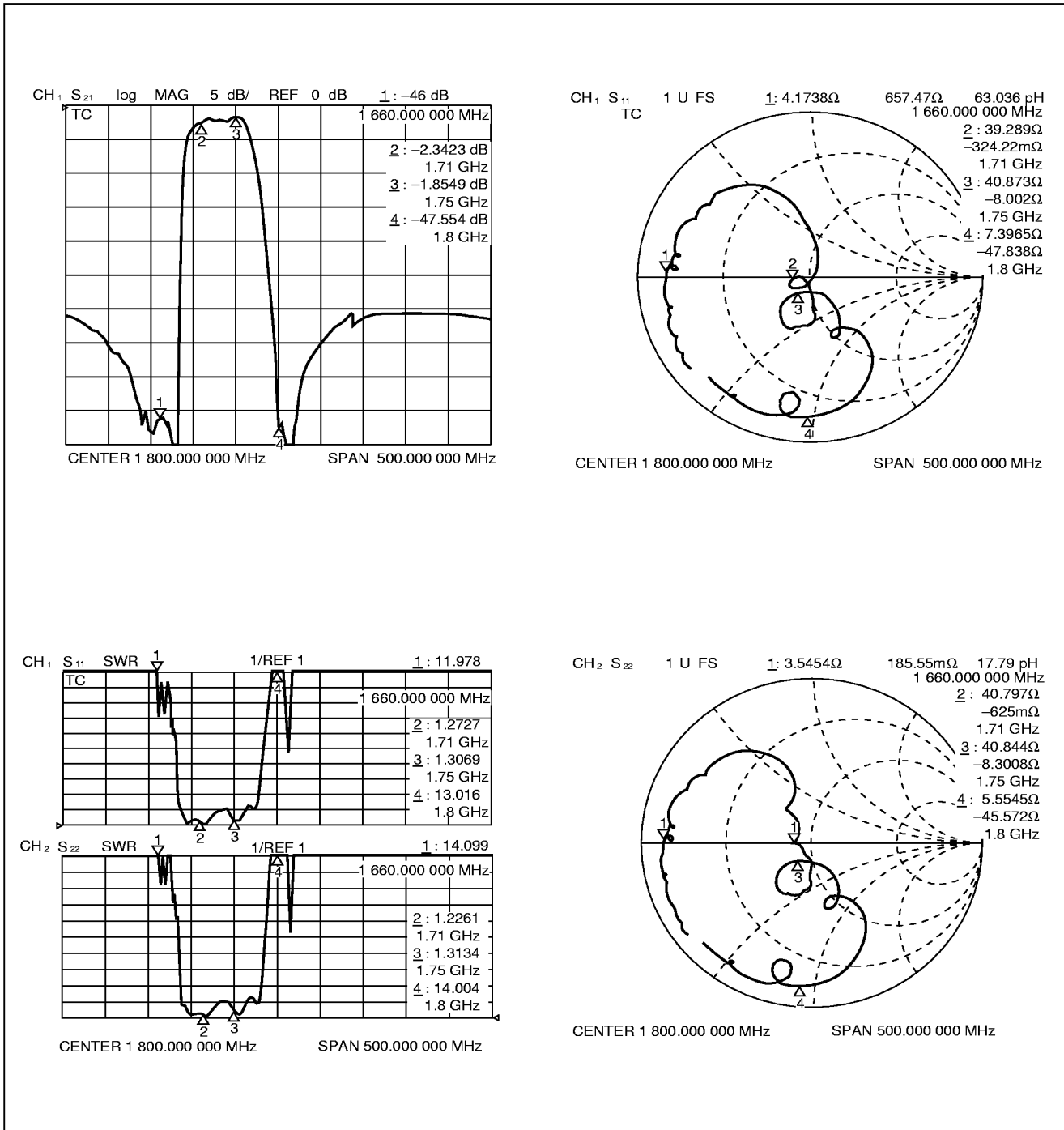

F6 Series (L2 type)

11. Korea-PCS (Tx) Upper 30 MHz Band Width Part number: FAR-F6CE-1G7650-L2TA

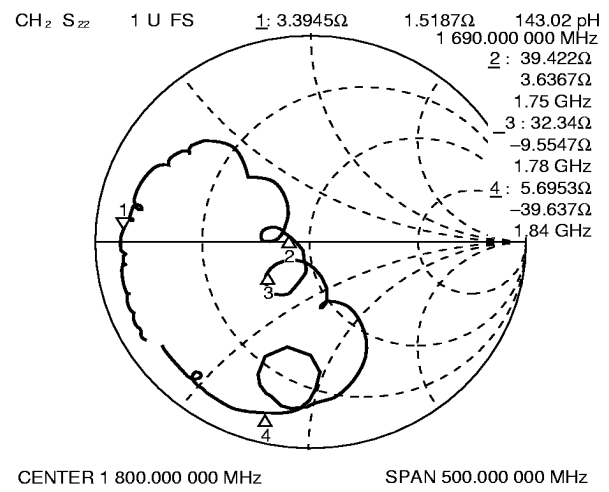
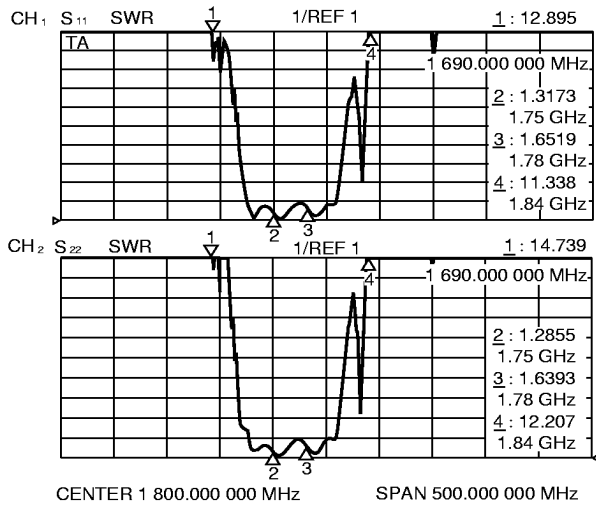
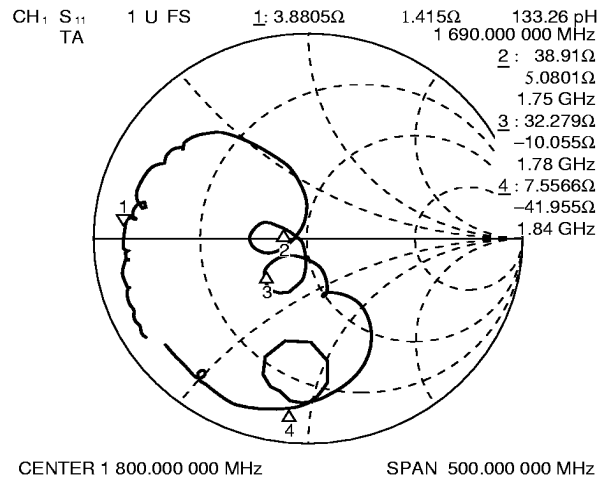
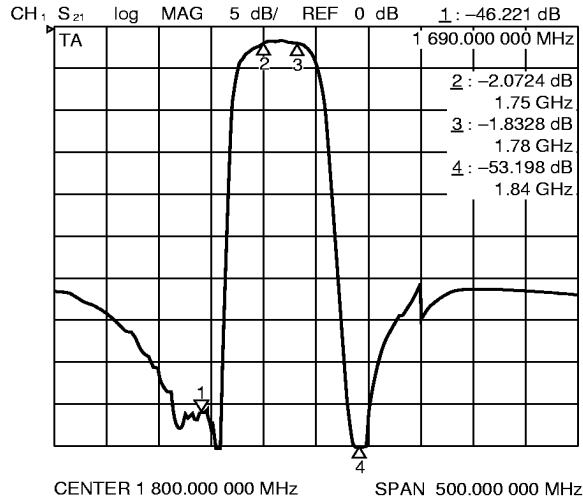

F6 Series (L2 type)

12. Korea-PCS (Rx) 60 MHz Band Width Part number: FAR-F6CE-1G8425-L2YBC

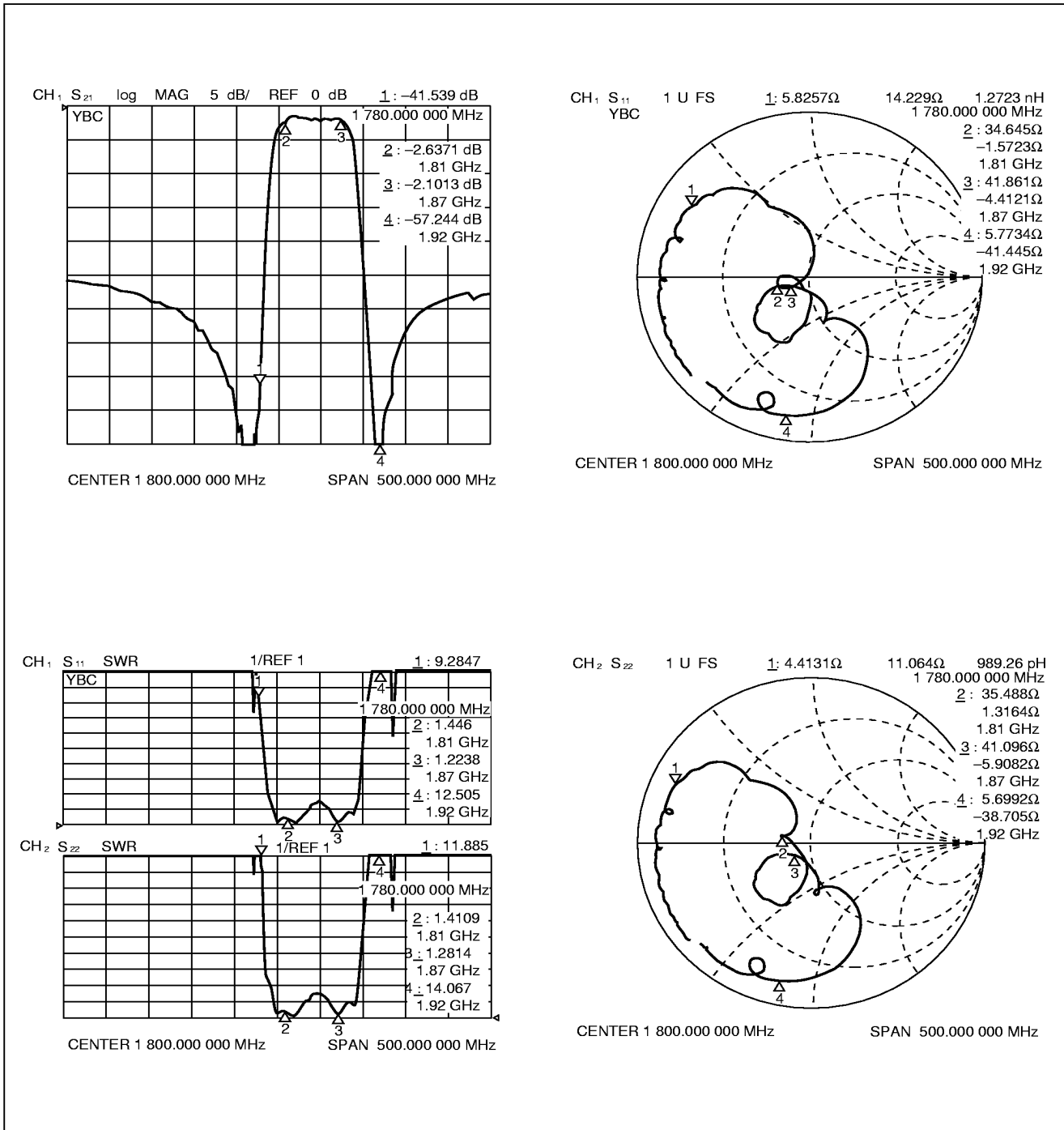

F6 Series (L2 type)

13. Korea-PCS (Rx) Lower 40 MHz Band Width Part number: FAR-F6CE-1G8200-L2TD

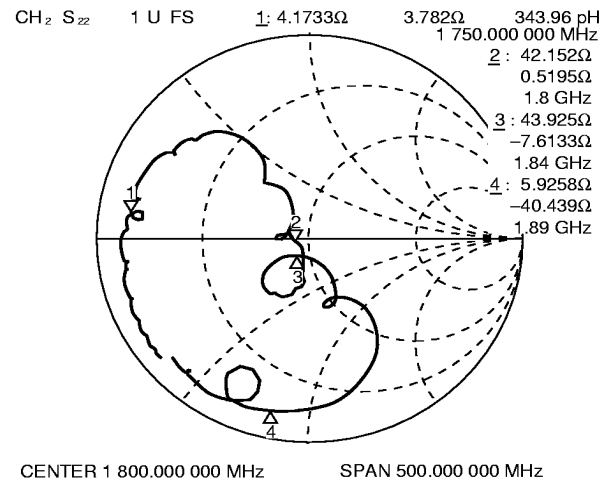
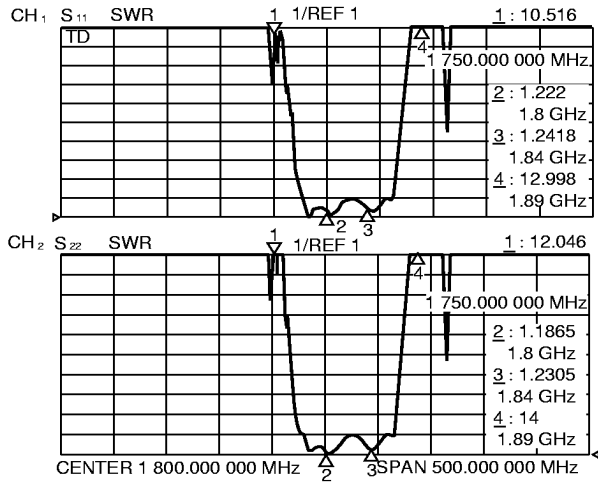
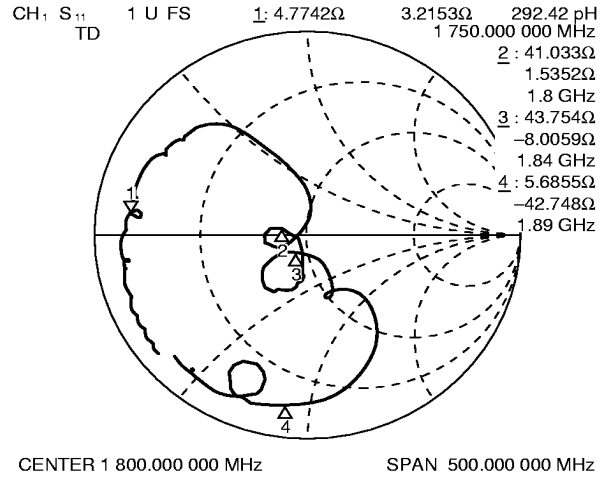
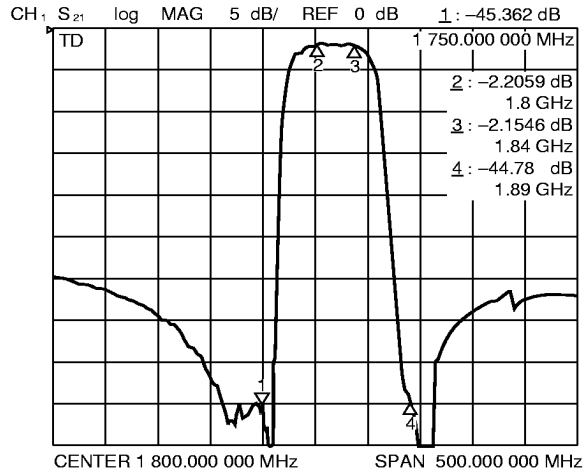

F6 Series (L2 type)

14. Korea-PCS (Rx) Upper 30 MHz Band Width Part number: FAR-F6CE-1G8550-L2TB

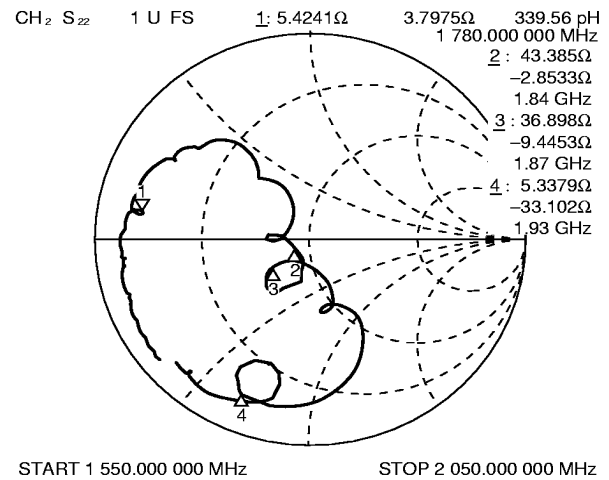
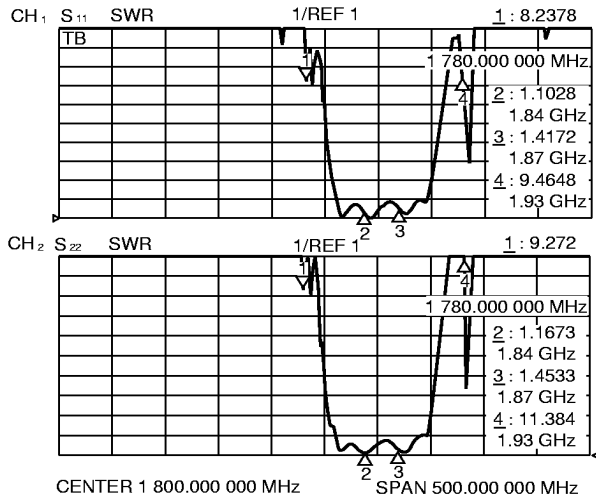
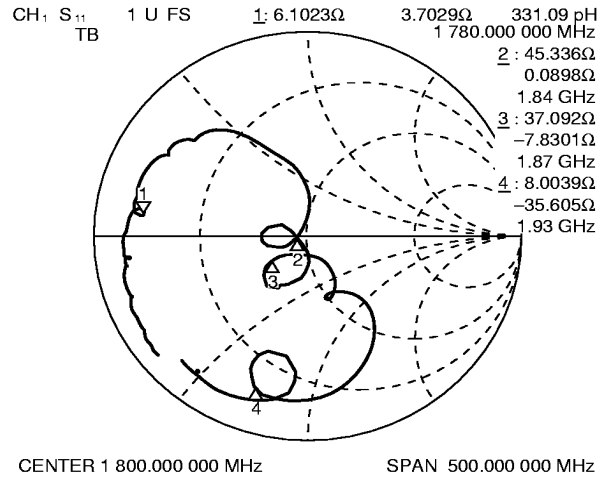
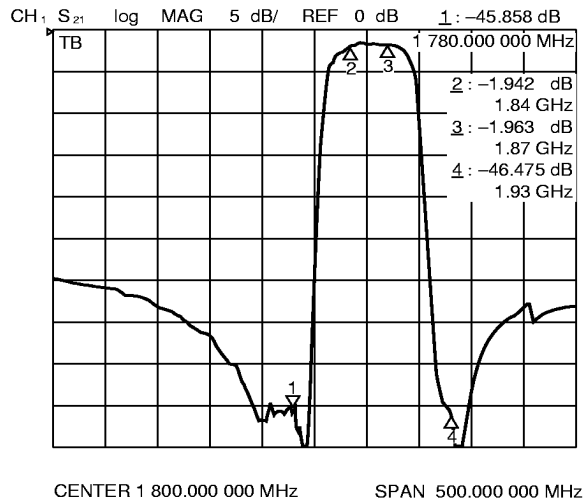

F6 Series (L2 type)

15. Wireless-LAN 97 MHz Band Width Part number: FAR-F6CE-2G4500-L2WA

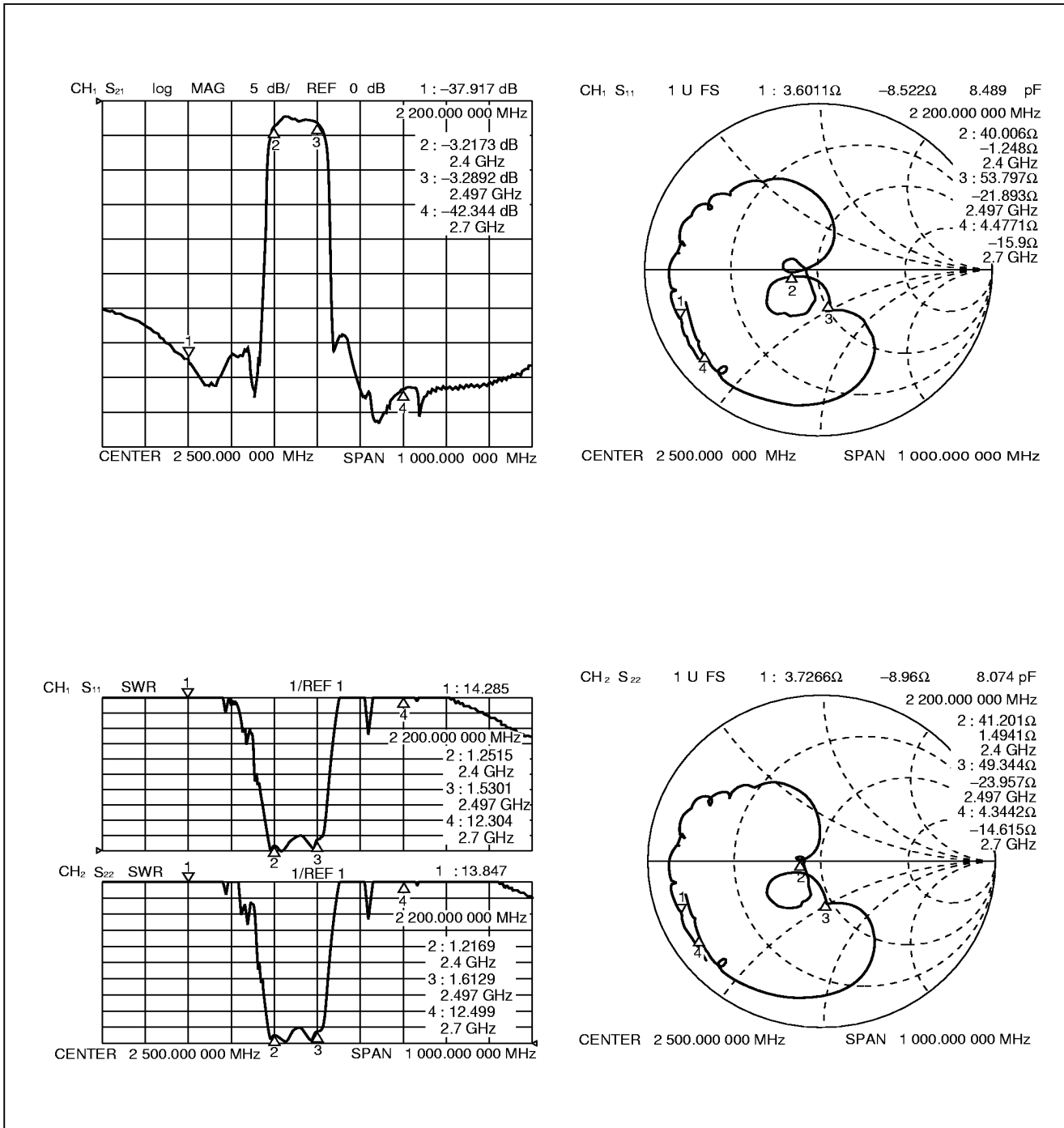

F6 Series (L2 type)

16. Wireless-LAN 26 MHz Band Width (For Japan) Part number: FAR-F6CE-2G4840-L2WC

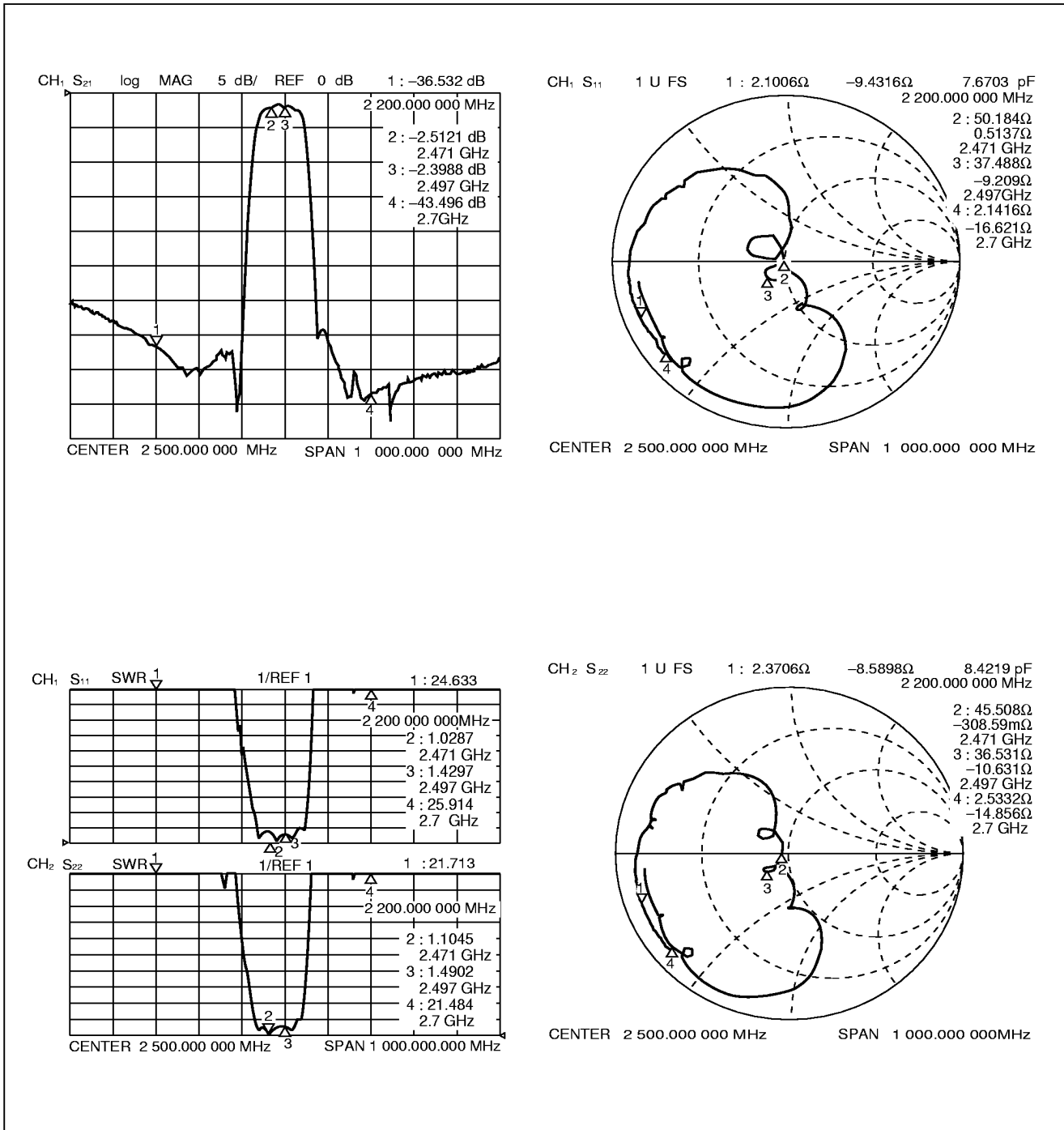

F6 Series (L2 type)

17. Wireless-LAN 83.5 MHz Band Width (For Europe, USA)

Part number: FAR-F6CE-2G4418-L2WD

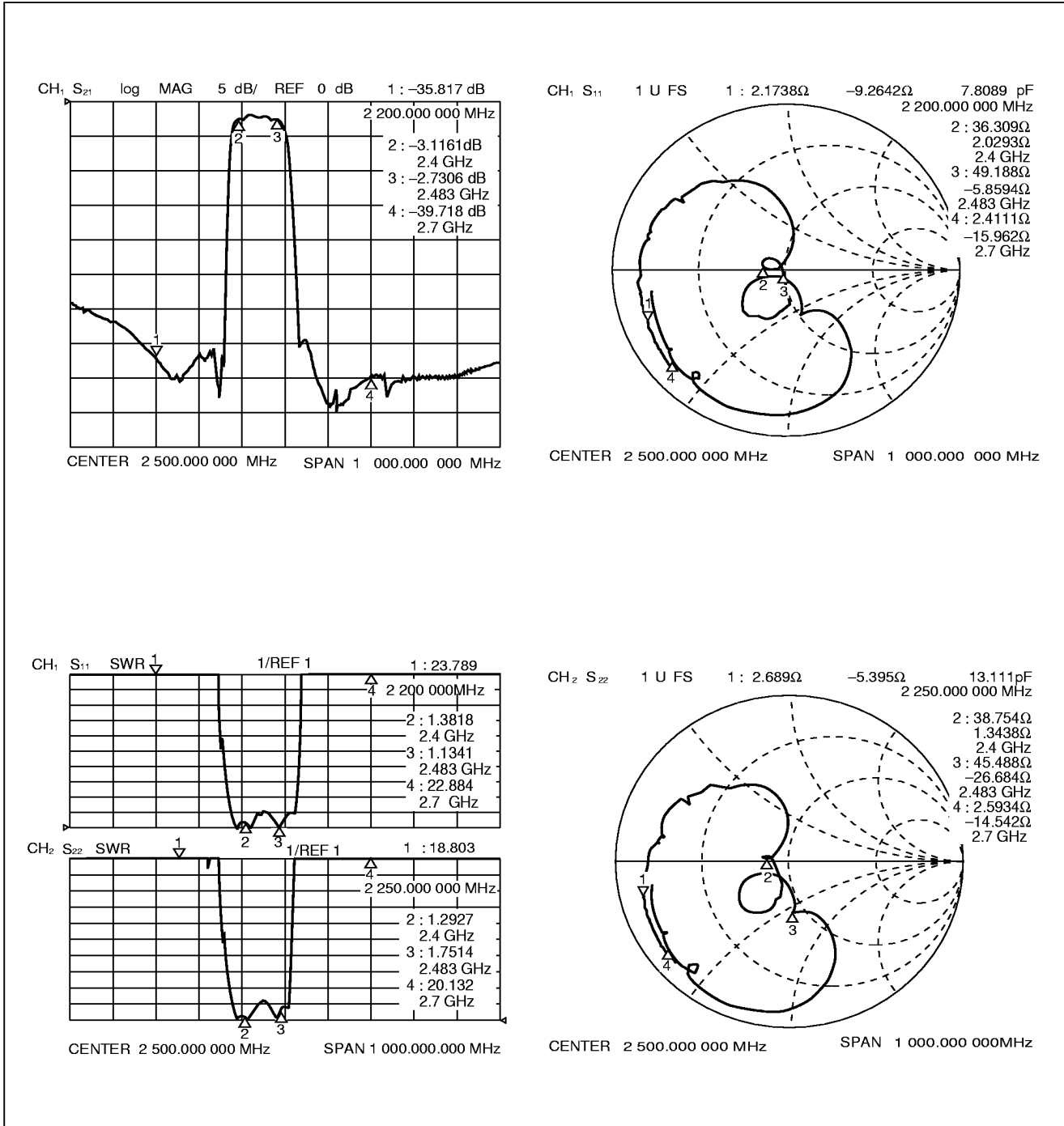

F6 Series (L2 type)

MEASUREMENT CIRCUIT

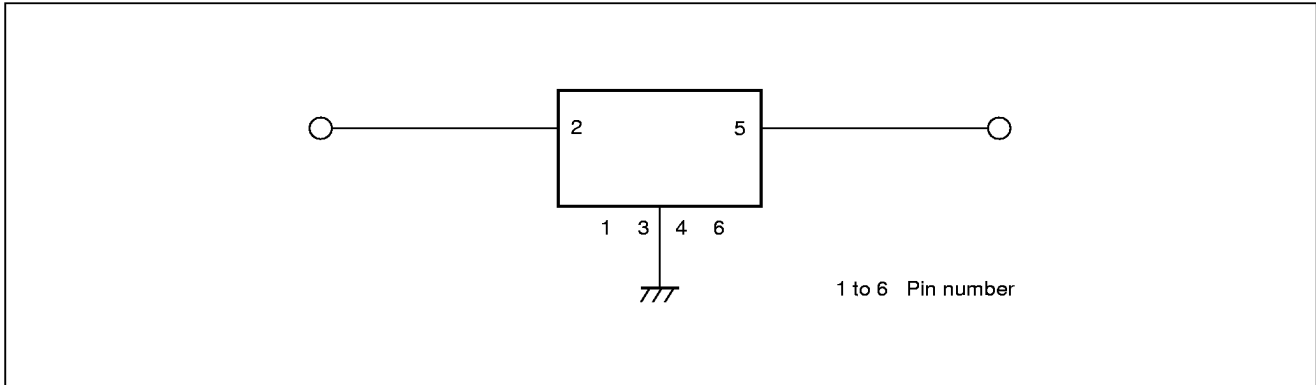

PART NUMBER DESIGNATION

[Designation example]

FAR-F6CE-□□□□□□-L2□□-□
 (1) (2) (3) (4)

- (1) Package designation : E: 3.0 mm sq. × 1.2 mm (height)
- (2) Frequency designation : Specify the nominal frequency in six alphanumeric characters.
 Enter G (for GHz) at the decimal point.
 Refer to standard frequencies.
 [Example] 1.8800 GHz ⇒ 1G8800
- (3) Serial number : Specify a characters from WA to ZZ.
 Refer to standard frequencies.
- (4) Packing (Reeled tape) : W : 1000 pcs/reel
 V : 3000 pcs/reel
 U : 5000 pcs/reel

MARKING

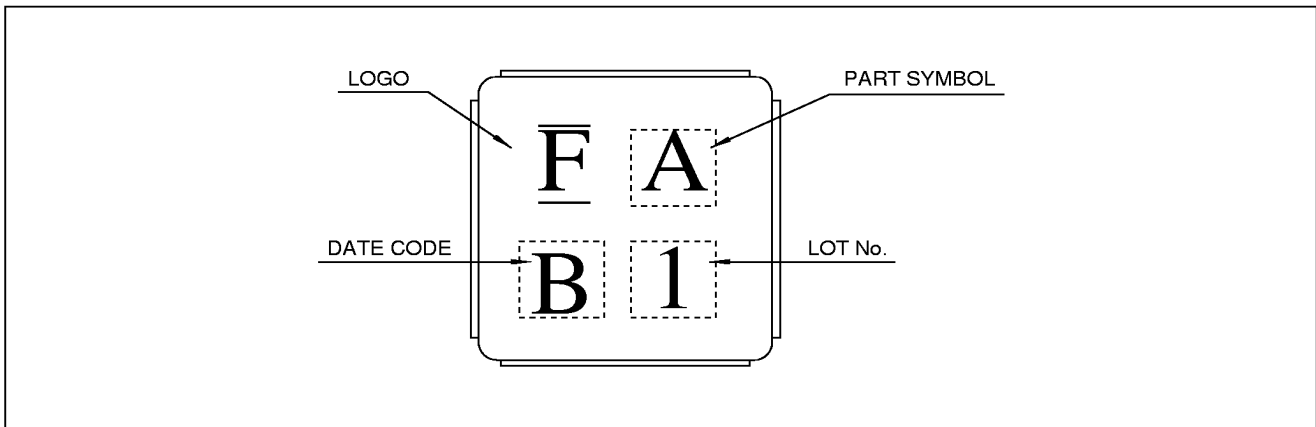

F6 Series (L2 type)

■ PACKAGE DIMENSIONS

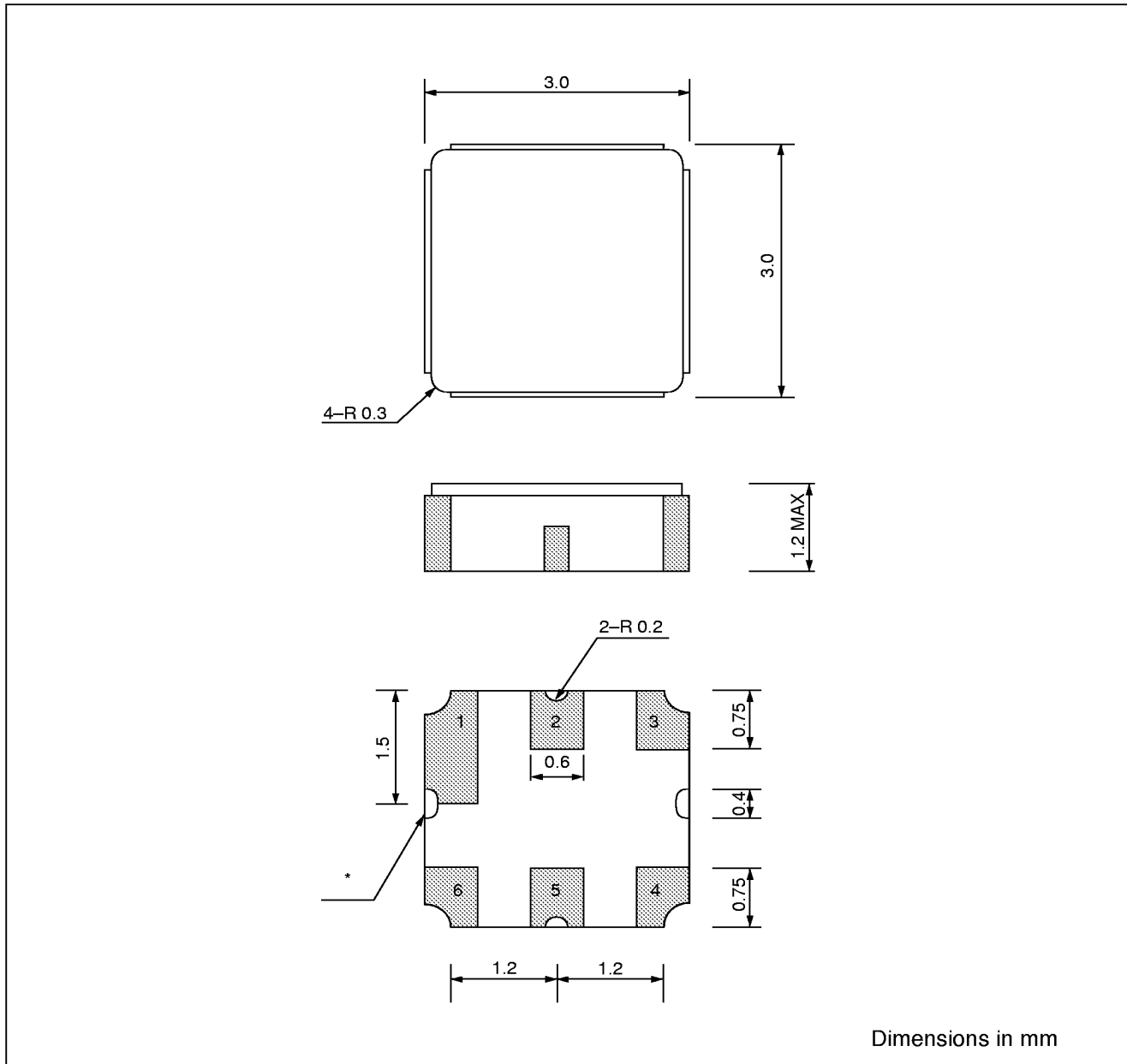

Dimensions in mm

* : Two types of package are available.
One of them has this castration, the other one doesn't have it.

F6 Series (L2 type)

■ PACKING: Reel type

(1) Reel dimensions

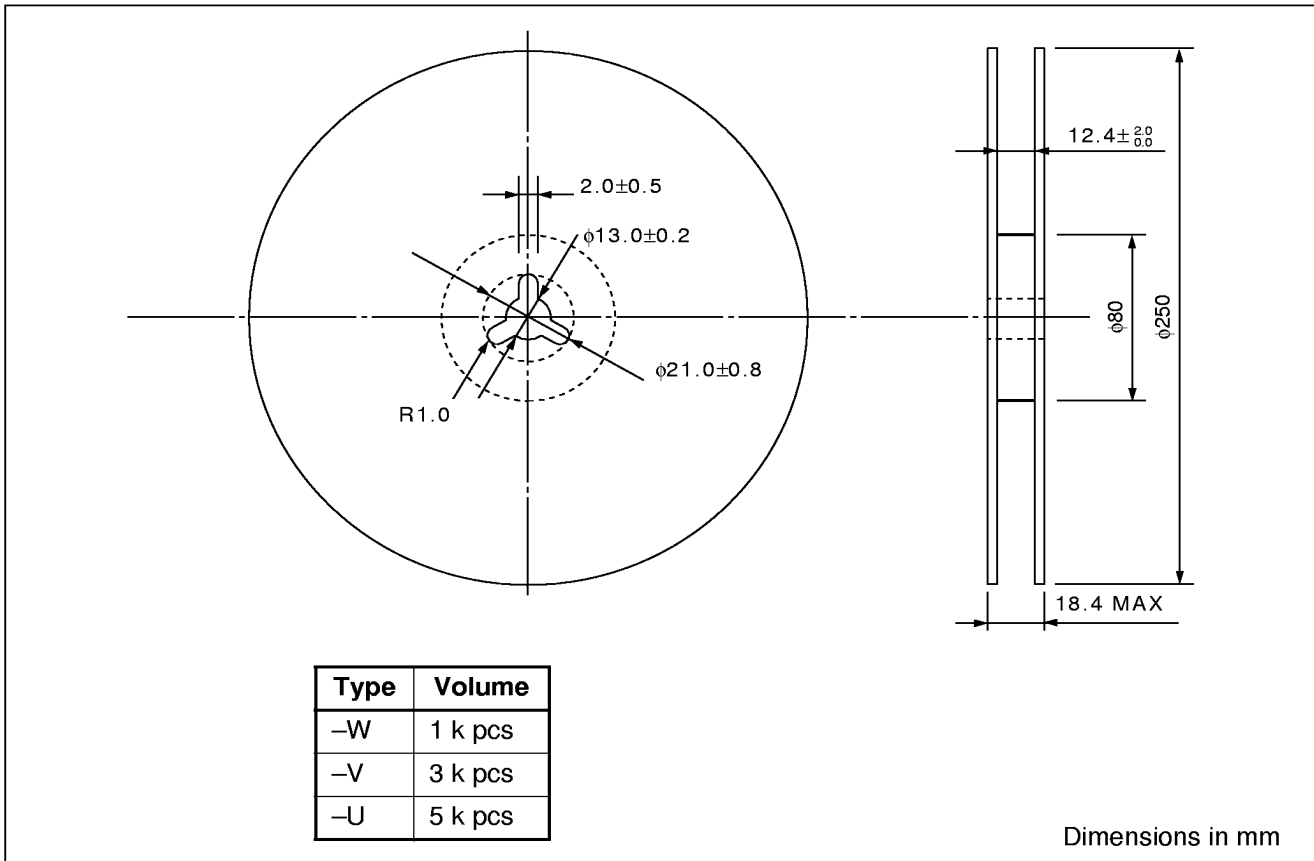

(2) Packing style

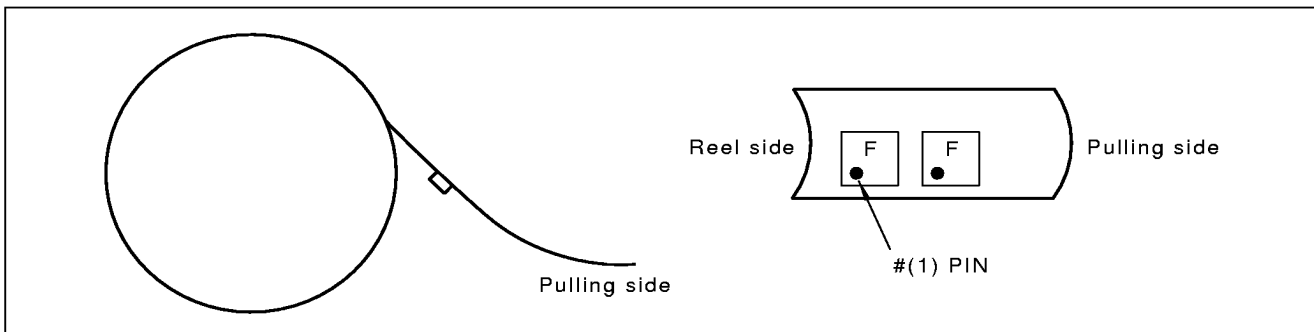

F6 Series (L2 type)

(3) Tape dimensions

